

SECTION A-A

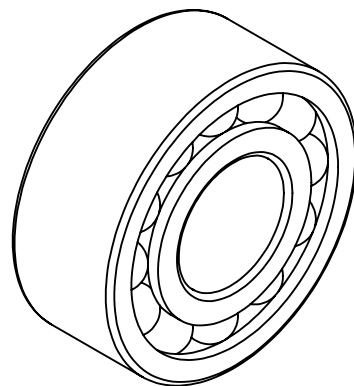

High Temp Bearings

TITLE:

Double Row Deep Groove Ball Bearing

SIZE DWG. NO.

A

4202

REV

A

SCALE: NTS

WEIGHT: 0.06Kg

SHEET 1 OF 1